



IMPROVING THE SKETCHING ABILITY OF ENGINEERING DESIGN STUDENTS

Hilton, Ethan Clark (1); Paige, Myela (1); Williford, Blake (2); Li, Wayne (1); Hammond, Tracy (2); Linsey, Julie (1)

1: Georgia Institute of Technology, United States of America; 2: Texas A&M University, United States of America

Abstract

From improving spatial visualization skills to concept generation, sketching is both a useful practice and a powerful tool for engineering designers. The method of teaching free-hand sketching in engineering courses has changed little in recent decades as CAD programs become more prevalent. This paper discusses a new method of teaching free-hand sketching in engineering design using pedagogy borrowed from Industrial Design curricula focusing on perspective sketching. An experiment comparing pre- and post-course sketches shows how the perspective method and more traditional method of teaching sketching impact students' sketching ability. The experiment finds that students in the perspective-based sketching course are more likely to improve their sketching ability over the course of the semester. Observing improvements in sketching ability could lead to observations in correlations between sketching ability and other necessary skills in engineering design. These observations could greatly impact our understanding of successful designers and how to train students in engineering design courses.

Keywords: Design education, Visualisation, Communication, Sketching

Contact:

Ethan Clark Hilton
Georgia Institute of Technology
George W. Woodruff School of Mechanical Engineering
United States of America
ethan.clark.hilton@gmail.com

Please cite this paper as:

Surnames, Initials: *Title of paper*. In: Proceedings of the 21st International Conference on Engineering Design (ICED17), Vol. 9: Design Education, Vancouver, Canada, 21.-25.08.2017.

1 INTRODUCTION

Free-hand sketching has been highlighted as an important part of engineering design by several studies. Spatial visualization has long been considered a key skill for engineering students in all disciplines as it allows student to approach problems from several viewpoints (Sorby and Baartmans, 2000), and sketching has been seen as a proven technique in developing and strengthening this crucial skill (Sorby, 2009; Olkun, 2003). Sketching is also a strong tool for the early design phases as ideas are generated, recorded, and built upon (Yang, 2009). There is even consideration that well-developed sketching skills will improve design ability, especially in early-stage design (Yang and Cham, 2007).

Therefore, even as CAD methods have become more advanced, it had remained necessary to educate engineering design students in free-hand sketching including borrowing methods from Industrial Design curricula (Hilton et al., 2016a) and using tablet-based programs to assist in teaching sketching electronically (Kumar et al., 2016).

1.1 Teaching Methods

This paper focuses on two different methods for teaching sketching in an Introduction to Engineering Graphics course and the effects each method has on the students' ability to sketch. The first method will be referred to as the Traditional method of the course. This method focuses on more of the basics of engineering drawing such as drawing in isometric view (see Figure 1) and drafting. The second method of teaching the course will be referred to as the Perspective-based method and uses pedagogy often utilized in Industrial Design curricula involving techniques such as sketching in perspective, where the lines of the object being sketched converge to "vanishing points" to create an understanding of proximity between objects (Figure 1).

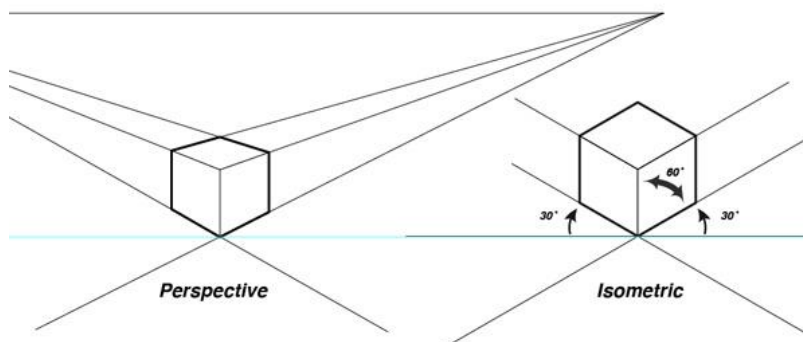

Figure 1. Cubes Represented in Perspective and Isometric Views

1.1.1 Traditional Method

Introduction to Engineering Graphics is a freshman-level engineering course in the Mechanical Engineering department at the Georgia Institute of Technology. The fifteen-week course aims to teach students how to successfully represent their engineering designs through the means of sketching and computer-aided design (CAD) software. The first five weeks of the course are dedicated to isometric and orthographic sketches, often using lined grid paper and/or straight edges, protractors, and other drawing tools. These sketches are intended to teach students how to properly indicate dimensions and prepare them to generate images in a CAD system. The remainder of the course (about 10 weeks) focuses on creating representations in CAD programs, including creating electronically-developed 2D engineering drawings similar to those drawn by hand at the beginning of the semester.

1.1.2 Perspective-based Method

The perspective-based method of the course is listed as the same course as the traditionally-based course and covers the same general topics. The only major differences come in the first five weeks of the course, during the sketching portion of the class. The perspective-based method draws heavily from pedagogy

used in Industrial Design sketching courses including lessons in methods such as shading and ray-tracing, perspective views, and thumb-nailing (sketching several small views of one object). The assignments in these sections are much more sketch-heavy. The students are given fewer constraints on what they can sketch, and are graded more on form and technique than for dimensioning. The goal is to develop the ability to create quick, realistic sketches of design ideas to allow the student to form a better understanding of how the object looks and behaves in space. The students utilize techniques learned in the class such as perspective, adding objects in the foreground and background to help dictate the size of the object, and adding lighting effects such as shading to bring a more realistic feel to their sketches. The perspective version also requires hand-drawn sketches of the final CAD-based project to show their design process. Pre- and post-course sketches from students taught in each method are shown in Table 1.

Table 1. Sketch Samples from Students

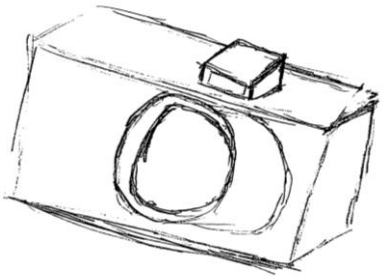
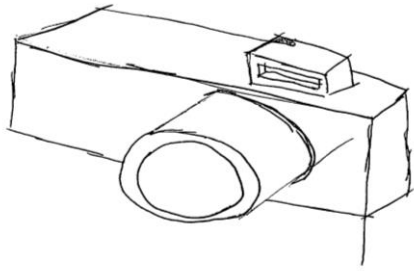
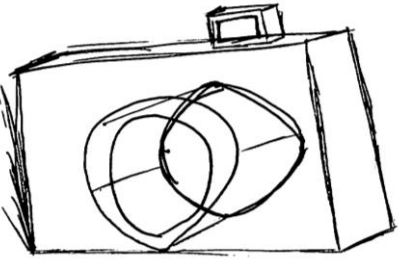
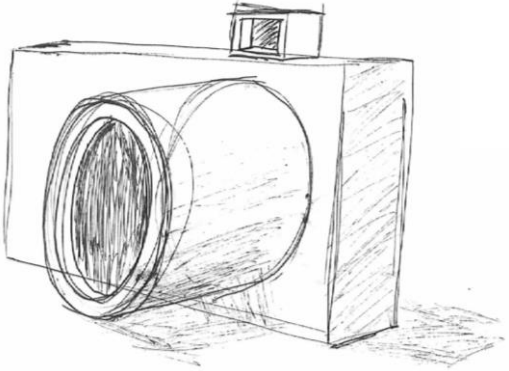
	Pre-course	Post-course
Traditional Method		
Perspective Method		

2 PREVIOUS WORK

Previous studies have observed the effects of these two different methods and attempted to determine whether there were any significant impacts on skills such as spatial visualization and design self-efficacy (Hilton et al., 2016a). These measures are convenient to observe due to the available scales that can be used to measure them. This study found that there were no significant differences in the changes in these metrics experienced by students in each version of the course. However, there was an observation of the students' sketching ability. Table 1 shows the pre-course and post-course sketches of two students: one in the Traditional course and the other in the perspective-based course. The students in the perspective course seemed to be improving at a higher percentage than those in the traditional course, but there was no way to measure this other than these qualitative observations as there are for spatial visualization and design self-efficacy.

In order to attempt to understand the improvements being made by the students, another previous study utilized subject-matter experts in the field of free-hand sketching and sketching education to rank the

work of several students (Hilton et al., 2016b). This study found that more complicated sketches, such as the cameras shown in Table 1, could be consistently evaluated by raters.

3 RESEARCH QUESTION

As previous studies have explored the question of how the style of teaching sketching impacts spatial visualization skills and design self-efficacy, this study focuses more on the impact on the students' ability to sketch by comparing each student's pre- and post-course sketches to each other. To explore this concept, we pose the following research question:

Does teaching perspective-based sketching in an engineering design course improve sketching ability at a more consistent rate than teaching more traditional engineering sketching?

Based on qualitative observances such as those seen in Table 1, the following hypothesis is reached for the research question:

Teaching perspective-based sketching in an engineering design course will more consistently improve students' sketching ability than teaching traditional engineering sketching.

4 METHODOLOGY

In order to collect a sample of sketches from each student, a paper-based quiz was developed (Hilton et al., 2016b). This quiz follows a pedagogy described as mastery-based (Bloom, 1968) with a progression of exercises beginning with simple straight lines and culminating in the student sketching a three-dimensional camera in two-point perspective based on an example of three planar views of the camera. A few of the exercises required by the paper-based quiz can be seen in Figure 2.

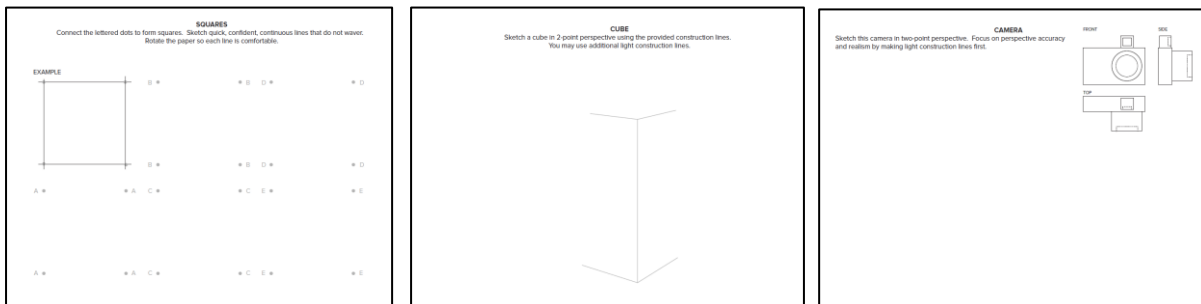

Figure 2. Portions of Sketching Quiz

Students taught using each method took the quiz during the lab portion of the first week of class and again during the last full week of class before finals. The participants were given no constraints on time or writing utensils, but were kept from using tools, such as straight edges and erasers. For their participation in the study, the participants received their choice of a monetary or extra credit incentive. After collection of the post-course data, each participants' pre- and post-course sketches were matched together to ensure comparisons took place between the same participant. To attempt to get an even selection from each experiment group, one section that used the traditional method and one section that used the perspective method of teaching was randomly selected for comparison. Only participants who completed both the pre-course and post-course study were considered as part of the data, resulting in 31 observed data points from the traditional method group and 42 observed data points from the perspective method group for a total of 73 data points. As a previous study (Hilton et al., 2016b) indicates the camera exercise to have the potential to be consistently evaluated, the camera sketches were scanned and uploaded to an online survey host as de-identified data. These surveys were given to raters with experience in teaching and evaluating sketching. Each rater was presented with pairs of sketches, the pre- and post- from a single participant. The sketches were randomized to hide which represented pre-course data or post-course data and in random order to hide the experiment group of the participant. The rater was asked to determine which sketch was of better quality and if it was slightly better or much better than its counterpart. In an effort to ensure the ratings were reliable, another rater went through the

same 73 data points. The results from both raters were compared to check for inter-rater agreement. An example of what the raters saw for each participant is shown in Figure 3.

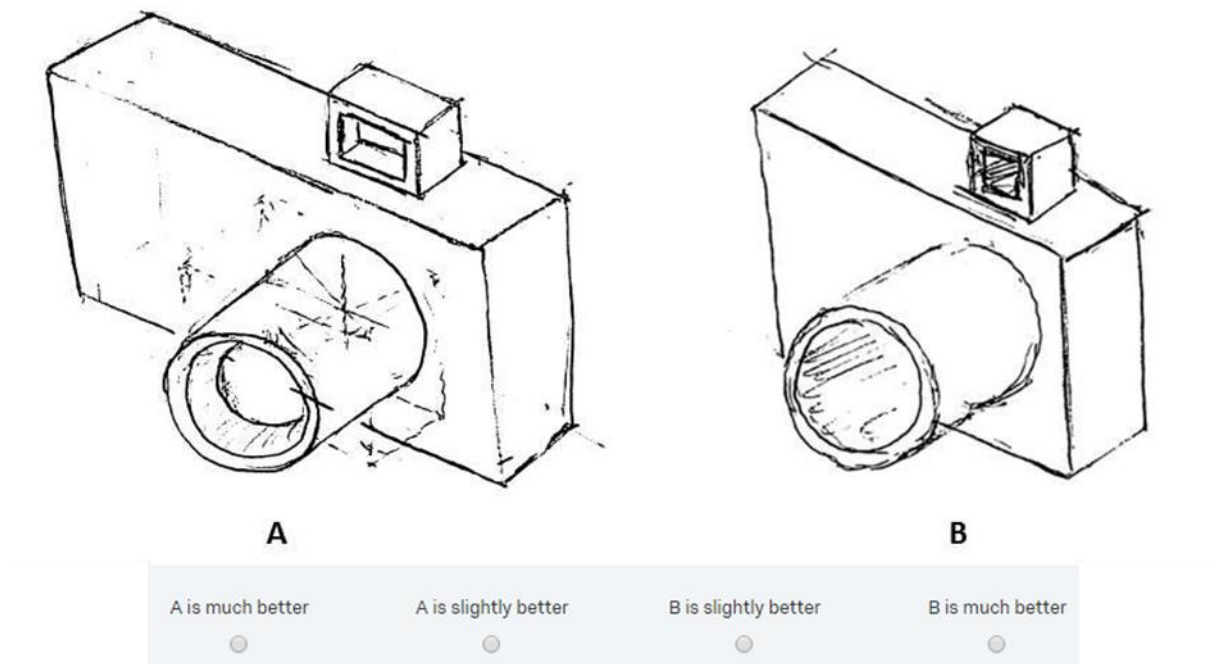

Figure 3. Example of Survey Question for Raters

5 PRELIMINARY RESULTS

Through the steps laid out in the Methodology section, preliminary data was obtained. Each data point was given a numerical value based on the qualitative response from the survey.

- Pre-course sketch was much better: -2
- Pre-course sketch was slightly better: -1
- Post-course sketch was slightly better: 1
- Post-course sketch was much better: 2

These quantitative values allowed for statistical tests to be run in order to determine if there were significant differences between the two groups.

5.1 Continuous Data

Using the values dictated above, we can treat the data as continuous data. The sketches from the perspective-based course were most frequently rated as the post-course sketch was slightly better than their pre-course sketch. The sketches from the traditional course were most frequently rated as the post-course sketch was slightly worse than the pre-course sketch. The frequency of each value for the two groups can be seen in Figure 4. The average score of the traditionally taught course was 0.129 while the average score of the perspective-based course was 0.667 (see Figure 5). Running a two-sample t-test returned a p-value of 0.044 ($t = 1.99$, $df = 71$), assuming the t-test assumptions of equal variances and normally distributed data are met (Cohen, 1988).

5.2 Binary Data

Another way the ratings were analysed was by treating them as a binary metric. Any rating that found the post-course sketch to be improved over the pre-course sketch was considered a success. From the traditional course, 16 of the 31 participants (about 52%) saw improvement in their post-course sketch rating. From the perspective-based course, 32 of the 42 participants (about 76%) saw improvement in their post-course sketch rating (see Figure 6). As this is binary data, we can compare these proportions using the N-1 Chi-squared test to determine if the groups are significantly different (Pearson, 1900).

Running this test returned a p-value of 0.029 ($z = 2.19$, $df = 71$), assuming the chi-squared assumptions of a significant amount of data and independent groups were met.

5.3 Inter-rater Agreement

The ratings of both evaluators were compared to one another using a Pearson correlation to determine if the ratings can be considered reliable. When comparing the initial ratings using the quantitative scale outlined at the beginning of this section, the two raters have a Pearson correlation of 0.68. When using the binary method described in Section 5.2, the raters have a Cohen's Kappa of 0.62.

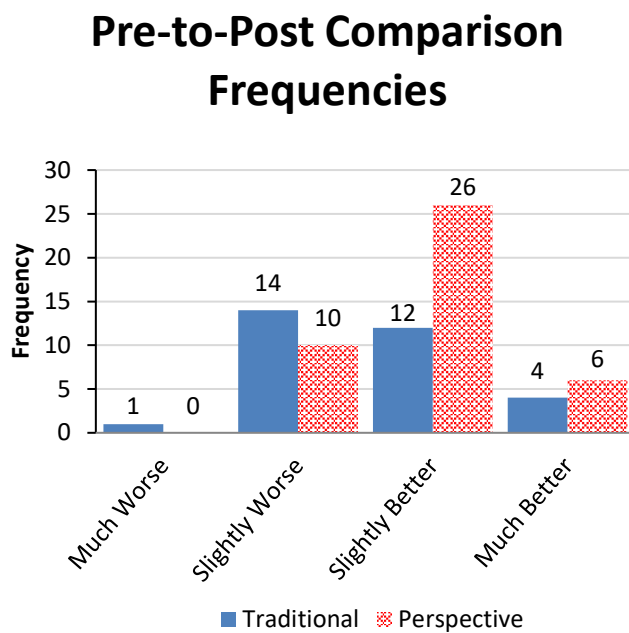

Figure 4. Rating Frequencies

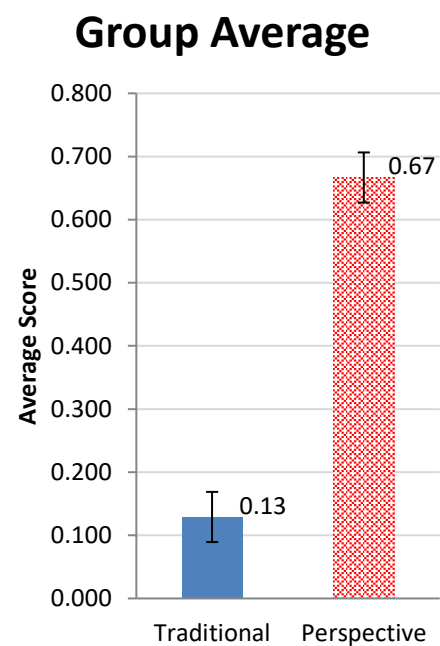

Figure 5. Average Score Per Group

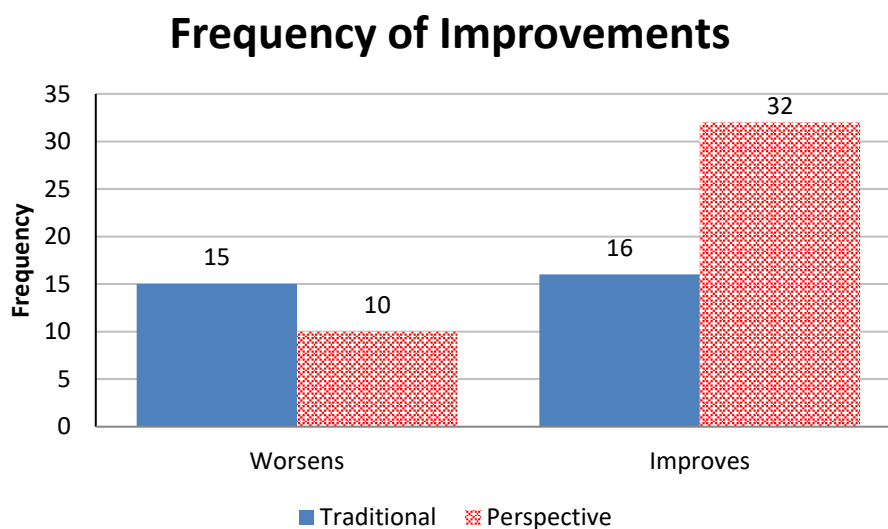

Figure 6. Improvement Frequency

6 DISCUSSION

The results presented in the previous section are preliminary, but crucial in understanding the effects of different methods of teaching sketching in engineering design.

6.1 Inter-rater Agreement

According to Cohen (1988), any Pearson correlation over 0.5 is considered a strong correlation in qualitative research and any Cohen's Kappa between 0.61 and 0.80 is considered substantial. Based on this standard, the Pearson correlation for the Continuous Data discussed in Section 5.1 and the Cohen's Kappa for Binary Data discussed in Section 5.2 both have strong correlations between the two evaluators. Therefore, we can consider the rating to be reliable.

6.2 Effects of Teaching Perspective Sketching

As both the p-value of the Continuous Data and the Binary Data is less than 0.05, it can be said that the two groups are significantly different (Pearson, 1900; Cohen, 1988). It is reasonable to say the assumption of equal variance is upheld for the continuous data. Figure 4 shows a possible normal distribution, but it may not be reasonable to argue that the data is normally distributed. However, it is reasonable to say that the data set is large enough to represent the population and that the two groups are independent of one another. As the assumptions are upheld, the chi-squared test performed on the Binary Data can be taken as a valid significant difference. Therefore, **the data presented in this paper supports the hypothesis that the perspective-based course more consistently improves the sketching ability of students in engineering design courses.**

This result is incredibly important as we work to understand how to best teach students how to use sketching in the process of engineering design. Also, as previous studies have found that the perspective-based version of teaching sketching did not negatively impact skills associated with sketching in engineering design (Hilton et al., 2016a), it is now evident that this new method improves sketching skills without sacrificing other important skills acquired in an introductory engineering graphics course.

6.3 Shortcomings of the Study

All of the ratings were performed by evaluators with a medium knowledge of sketching and sketching education. It could be argued that more experienced sketching instructors outside of the college of engineering would be better equipped to perform the sketching evaluations. Also, the rating system use was relatively rudimentary. Developing a more in-depth evaluation metric would create more reliable ratings. None of these shortcomings discount the importance or significance of the results of this paper, but instead point to more work that can be accomplished in this field.

7 FUTURE WORK

Finding significant evidence that perspective-based sketching education better improves the sketching ability of students in engineering design courses is a big step forward in exploring several questions in the field of representation in engineering design. A few of these questions involve topics such as best practices in engineering design representation, the correlation between sketching ability, and design ability, and how to best measure sketching ability.

7.1 Best Practices in Engineering Representation

While this paper has supported the notion that teaching perspective sketching improves sketching ability in students, the question still remains as to whether having improved sketching ability is beneficial to engineering designers and the skills they need to possess to be successful designers. One possible route forward includes observing students taught different methods of sketching in future design courses to observe whether or not these new skills prove beneficial. Another route involves searching for direct correlations between sketching skills and other key skills.

7.2 Potential Correlations between Sketching and Other Skills

The most important aspect in determining to what extent sketching matters in engineering design is to determine the impact sketching skills have on other key skills for engineering design. Previous studies

have shown that the style of sketching taught to students does not have a significant impact on skills such as spatial visualization (Hilton et al., 2016a). However, now that a more reliable method of evaluating sketching ability is beginning to form, sketching skill could be directly correlated to other skills necessary for engineering design.

7.3 Development of Reliable Method for Evaluating Sketching Ability

Previous studies have suggested it is possible for sketches to be consistently evaluated by subject-matter expert in sketching (Hilton et al., 2016b). Now we have found that it is possible to see the effects of different methods of teaching sketching on students' sketching abilities. As these pieces build off each other, it becomes possible, and necessary, to evaluate a consistent method of evaluating sketching ability that does not require a subject-matter expert and can also go beyond simply determining an improvement by one student. One possible solution may be to use Artificial Intelligence software that can recognize certain qualities of a sketch. Such software has begun to be developed and implemented in engineering graphic courses with promising results (Kumar et al., 2016).

REFERENCES

- Bloom, B. S. (1968), Learning for Mastery. Instruction and Curriculum. Regional Education Laboratory for the Carolinas and Virginia, Topical Papers and Reprints, Number 1. *Evaluation comment*, 1, n2.
- Cohen, J. (1988), Statistical Power Analysis for the Behavioral Sciences. 2nd edn. Hillsdale, New Jersey: L. Erlbaum.
- Hilton, E., Li, W., Newton, S. H., Almendar, M., Pucha, R. & Linsey, J. The Development and Effects of Teaching Perspective Free-Hand Sketching in Engineering Design. *ASME International Design Engineering Technical Conferences (IDETC)*, August 21-24, 2016 2016a Charlotte, NC, USA.
- Hilton, E., Williford, B., Li, W., McTigue, E., Hammond, T. & Linsey, J. (2016b), Developing a Consistent Method for Evaluating Sketching Ability. *The Fourth International Conference on Design Creativity*. Atlanta, GA.
- Kumar, S., Keshavabhotla, S., Hilton, E., Williford, B., Taele, P., Li, W., Linsey, J. & Hammond, T. (2016), PerSketchTivity: An Interactive Pen-Driven System for Guiding Users in Design Sketching Fundamentals. *User Interface Software and Technology Symposium (UIST)*, 29th.
- Olkun, S. (2003), Making connections: Improving spatial abilities with engineering drawing activities. *International Journal of Mathematics Teaching and Learning*, 3, 1-10.
- Pearson, K. (1900), X. On the criterion that a given system of deviations from the probable in the case of a correlated system of variables is such that it can be reasonably supposed to have arisen from random sampling. *Philosophical Magazine Series 5*, 50, 157-175.
- Sorby, S. A. (2009), Educational research in developing 3-D spatial skills for engineering students. *International Journal of Science Education*, 31, 459-480.
- Sorby, S. A. & Baartman, B. J. (2000), The Development and Assessment of a Course for Enhancing the 3-D Spatial Visualization Skills of First Year Engineering Students. *Journal of Engineering Education*, 89, 301-307.
- Yang, M. C. (2009), Observations on concept generation and sketching in engineering design. *Research in Engineering Design*, 20, 1-11.
- Yang, M. C. & Cham, J. G. (2007), An analysis of sketching skill and its role in early stage engineering design. *Journal of Mechanical Design*, 129, 476-482.

ACKNOWLEDGEMENTS

The authors would like to extend gratitude to Shalini Kumar, Swarna Keshavabholta, Seth Polsley, and Matthew Runyon for their work in in developing artificial intelligence software to help teach sketching in engineering design, Dr. Erin McTigue for their guidance in developing the necessary scales to record evaluations, Maggie Tanski for assisting in data collection, and Drs. Fu, Dorozhkin, and Pucha for allowing their students to participate in this study. Finally, the authors would like to acknowledge the National Science Foundation through which this study is funded via NSF grant no. 1441291/ 1441331. All views expressed in this paper are the authors' and do not necessarily reflect the views held by the National Science Foundation.