

VIBRATION ANALYSIS OF VACUUM CLEANER MOTORS

J. Tavcar and J. Duhovnik

Keywords: product re-engineering, vibrations, vacuum cleaner motor, natural frequencies

1. Introduction

Industrial practice has shown that over 80% of the activities in the developmental-design process involve improvements to known products or the introduction of only minor modifications [Pahl et al. 1993]. Product re-engineering is classified as variant or adaptive engineering design [Duhovnik et al. 1993]. An improved product preserves previous technology and is exchangeable with the previous product variant. Product improvement takes place throughout the entire product lifetime [Prasad 1996]. Changes or supplements to products presently being manufactured are problematic, because they are associated with changes in tools, stocks of the existing parts and influences on other parts of the assembly [Duhovnik 2001]. Product re-engineering and product supplementation is especially important for those products in which reliable operation is essential, in our case the vacuum cleaner motor.

2. An example of product re-engineering

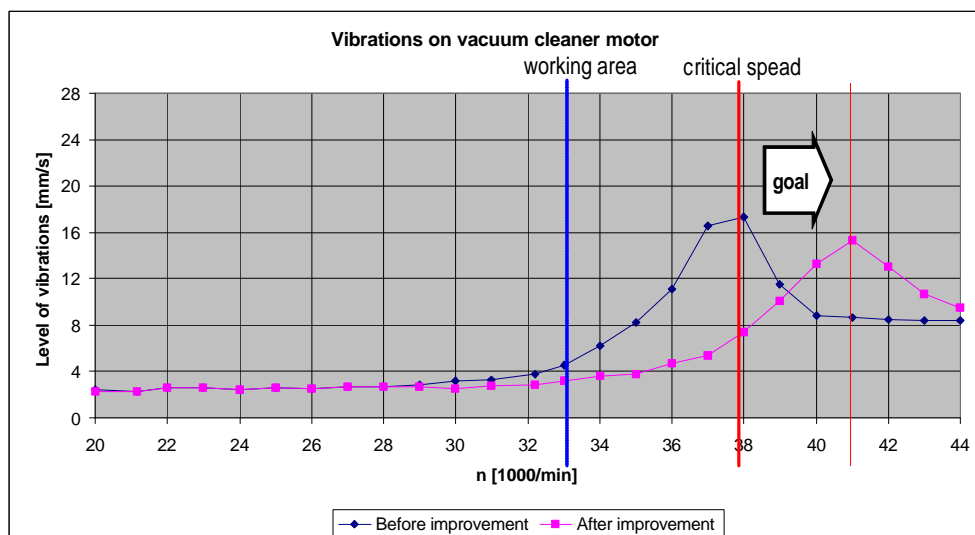

Figure 1. Level of vibrations vs. number of revolutions before and after product improvement

A description of product re-engineering is given using an example of a vacuum cleaner motor. The situation in the market required an increase in the number of revolutions, and thus operation in a range which was not anticipated during conceptual design. Fig. 1 shows the magnitude of radial vibrations of

the vacuum cleaner motor casing vs. the number of revolutions. At the critical rotational speed, the magnitude of vibrations increases considerably. The goal of the analysis was to increase the vacuum cleaner motor's natural frequency and thus enable an upward shift of its operating range.

The vacuum cleaner motor assembly (Fig. 2) is too complex for analytical mechanics and unsuitable for such an examination. An FEM-based numerical analysis with measurements is more appropriate. Literature on the topic of vibrations is extensive and various software tools for analysis and measurement are available [Harris 1996][Moretti 2000]. The question we asked ourselves was what is the most appropriate method for the analysis of assemblies. In our analysis we could not find any literature which would offer engineering design tips on how to increase damping and reduce vibrations. The basic principles can be inferred from the theory of vibrations, but they are difficult to generalize. This paper provides advice on how to influence the rigidity of the construction and consequentially on the vibrations of vacuum cleaner motors using engineering design solutions alone. The influence of rigidity of individual parts and subassemblies on the natural frequency of the entire vacuum cleaner motor is determined.

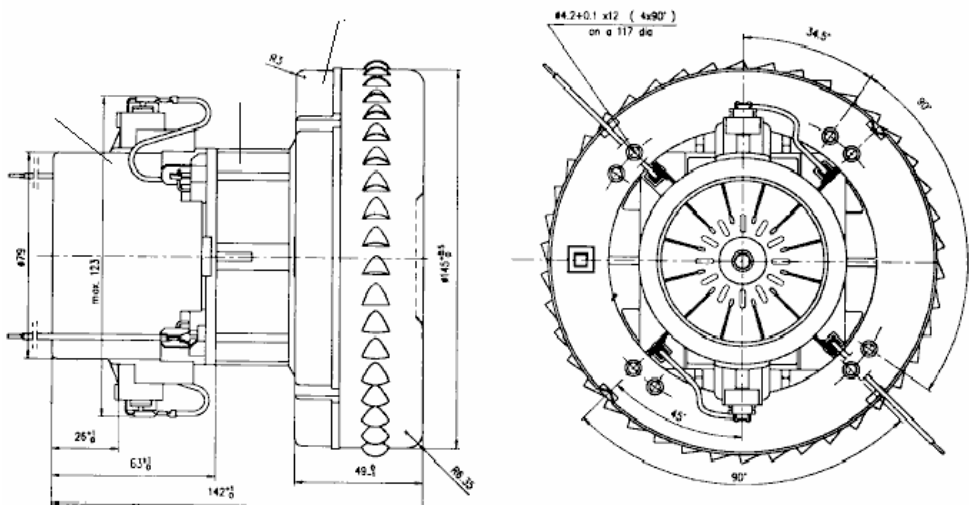

Figure 2. A Vacuum cleaner motor (a suction unit)

3. Methods of vibrations analysis

3.1 Finite elements method analysis

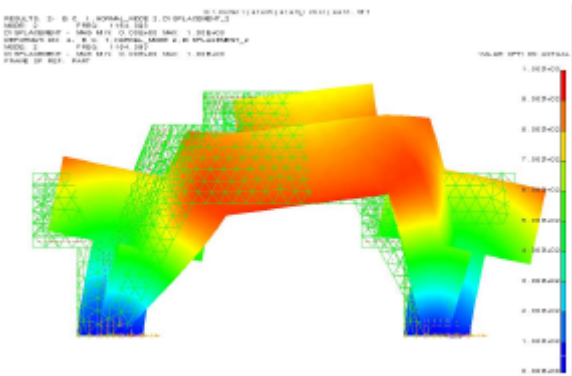

Figure 3. Second natural frequency shape of the rear end-bell

The advantage of **the finite elements method** is that we also get a graphic image of the particular natural vibration mode-shape (Fig. 3). This data is useful in positioning the reinforcements. The finite elements method enable also a precise calculation of natural frequencies for components which do not yet physically exist.

3.1.1 Optimising the front end-bell's geometry

Because of its joining role in the vacuum cleaner motor's construction the front end-bell significantly affects the vibrations. For this reason we have analysed what could be achieved by changing its design. The basic variants of the new designs are presented in the morfological matrix (Fig. 4). The objective in optimising the front end-bell's shape was to increase its rigidity without essentially increasing the dimensions.

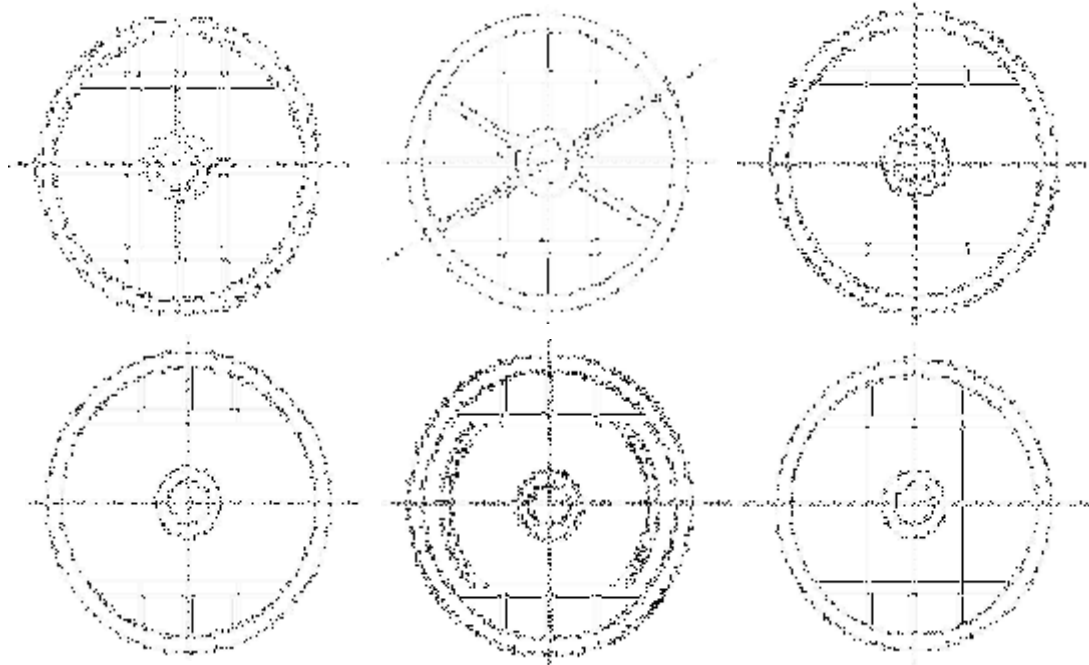

Figure 4. Morfological matrix of the front end-bell

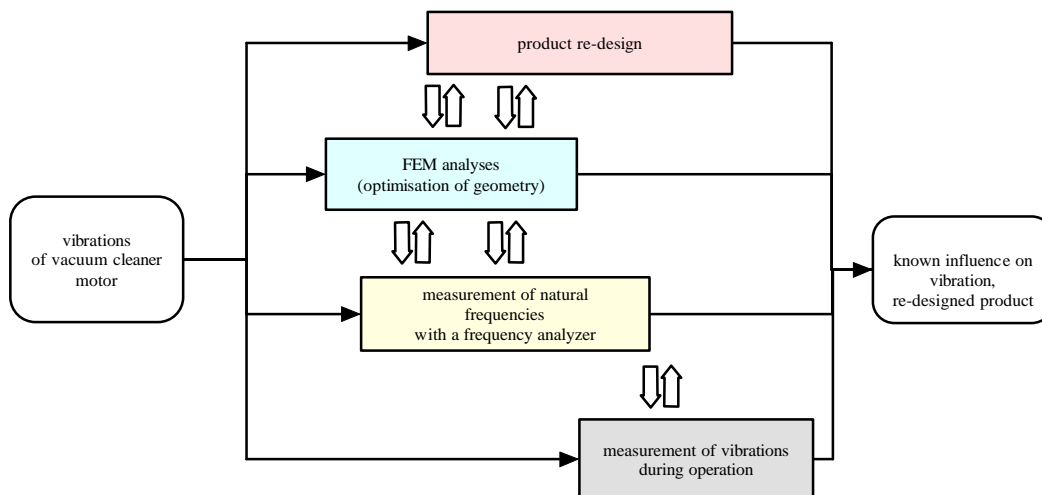

Figure 5. Different methods used for vibration analyses

3.2 Measurements with the frequency analyser

The fastest way of determining the natural frequencies of individual physical components is by measurement with a frequency analyser. The analyser represents a pre-set measurement chain. Vibrations are stimulated by a ball attached to a thread. The frequency analyser transforms the measured vibrations into the frequency spectrum (Fourier transformation) [Broch 1984].

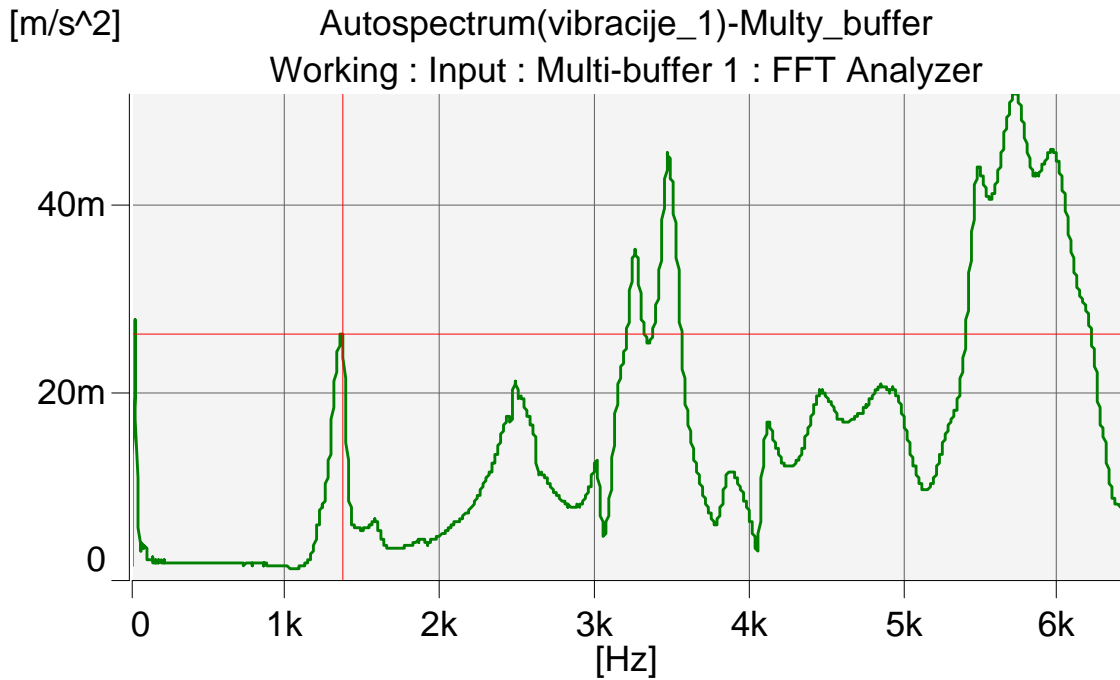

Figure 6. Example of the frequency response of an front end-bell. The first maximum shows the frequency of the first mode (~1400 Hz)

3.2.1 Measurements on the front end-bell, stator and rear end-bell unit

Measurements were made on the unit on the front end-bell, stator and rear end-bell, which are components of the screwed assemblage. The self-tapping screw was replaced with nuts and bolts so as to provide better control of screwing momentum and to be able to precisely adjust the joining force (Figure 7).

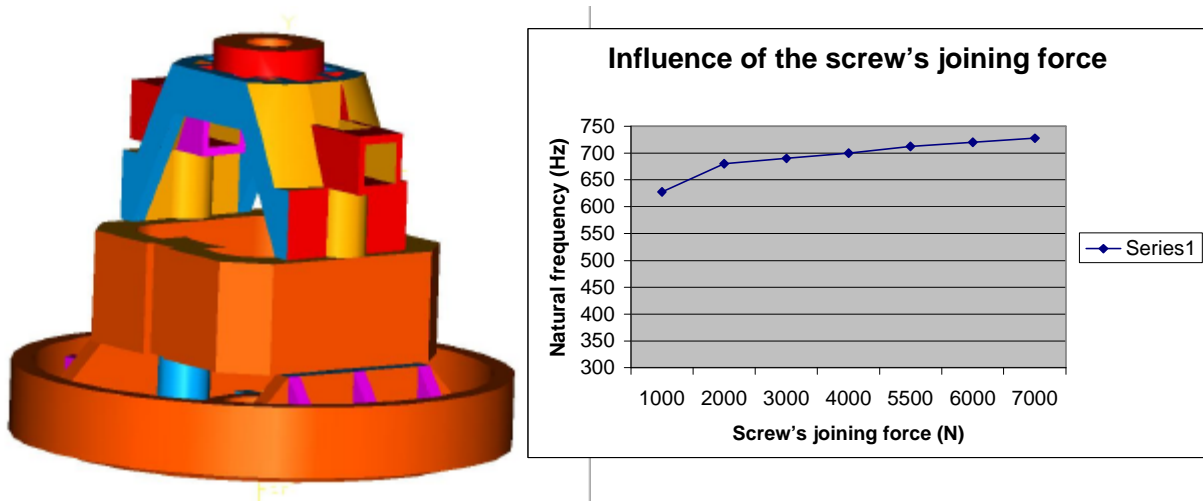

Figure 7. Front end-bell, stator, rear end-bell unit and the influence of the screwing force

Later the stator was altered, once without the coil, then with the coil, and finally we additionally screwed together the lamination to make it a rigid body (Fig. 8). The aim was to confirm the assumption that increased stator rigidity would reduce the influence of the joining force. Welding the lamination further increased the stator rigidity (Fig. 9). In another variant the stator rigidity was achieved with additional screws drawn through the oval openings at the stator's corners. Tested was also additional supports (4) between the front end-bell and the stator.

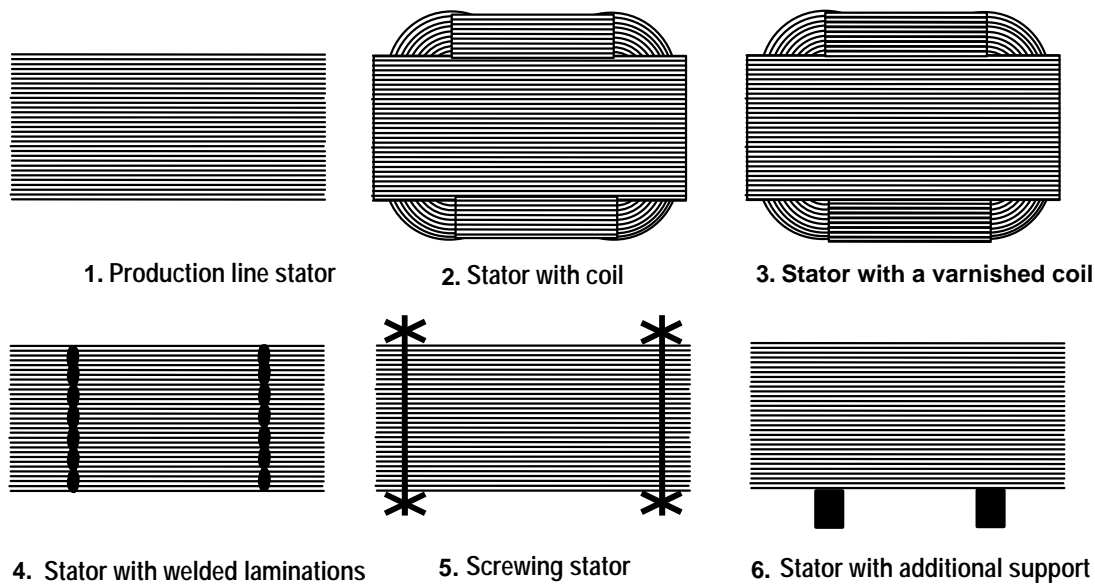

Figure 8. Morphological matrix of various stator construction

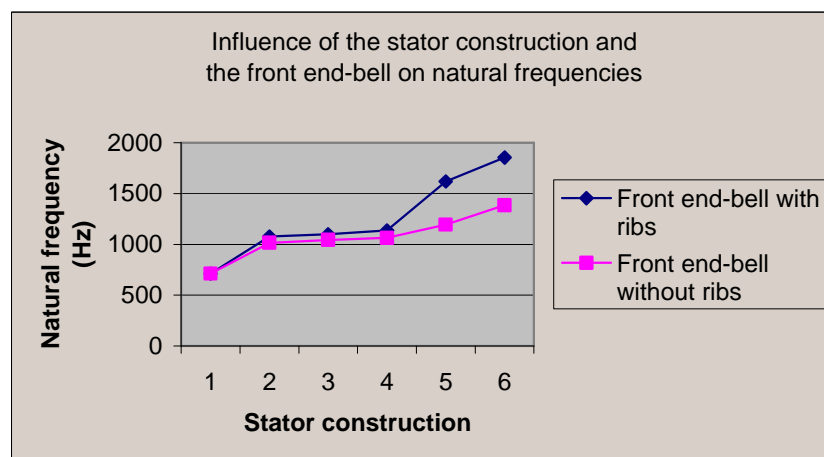

Figure 9. Influence of the stator construction and the front end-bell in the unit stator, front end-bell, rear end-bell on the unit's natural frequency. Stator construction: 1 – production line stator, 2 – stator with coil, 3 – stator with a varnish coil, 4 – stator with welded laminations, 5 – screwing stator, 6 – stator with additional support

3.3 Measurement of vibrations during operation

The vibration intensity is measured (the sensor is attached to the stator with a magnet) at a nominal voltage and with an opened and then with a closed vent. The revolutions increase with the increased voltage from 20,000 rpm onward, in steps of 1,000. The vibration level is measured and recorded and the peak position determines the critical revolutions (Fig. 1).

The tested vacuum cleaner motors required the use of all the above mentioned methods because they augment each other.

4. Conclusions

In addition to concrete results of vibration analysis of wet vacuum cleaner motors, the methods we used were also of value. Numerical analysis using the finite element method is very suitable for homogenous parts. In assemblies, numerical calculations are based on many assumptions. In

assemblies, measurements have proven to be the quickest way to get results. In any case, it is necessary to obtain verification by measurements performed on an operating vacuum cleaner motor.

The findings of our analysis can be summarised in the following engineering design rules:

- Where vibrations are concerned, there must be no weak element – the construction must be balanced. The weakest part determines the critical speed and improvements in other parts will not be helpful.
- The rigidity of jointing elements in the construction does not affect the natural frequency as much (e.g. the rare end-bell), but it does have a marked effect on the intensity of vibrations.
- In assemblies it is more effective to increase the rigidity by mutually connecting the components than by changing the shape of individual components (e.g. the casing).
- In assemblies it is difficult, lacking a thorough analysis, to identify the part which is causing vibrations.
- The analysis showed a great sensitivity of the vacuum cleaner motor natural frequencies to the distance between the bearings and the shaft diameter.

References

Peter M. Moretti, "Modern vibrations primer", CRC Press, Boca Raton, Florida, USA, 2000.

Jeans Tampe Broch, "Mechanical vibration and shock measurements", Bruel & Kjaer, K. Larssen & Son, 1984.

Duhovnik J., Tavcar J., "CE and Engineering Change Process Management", CERA International conference on Concurrent Engineering, USA, 2001.

Duhovnik J., Tavcar J., Koporec J., "Project Management with Quality Assurance", Computer Aided Design, Butterworth Heinemann, Oxford, Vol. 25, Number 5, pp 311-320, May, 1993.

Cyril M. Harris, "Shock and Vibration Handbook", McGraw-Hill, pp 14.1-14.42, 1996.

G. Pahl, W. Beitz, "Konstruktionslehre, Heidelberg", New York, Springer Verlag, 1993.

Biren Prasad, "Concurrent Engineering Fundamentals", Vol. I Integrated product and process organization, Technomic, Lancaster, USA, 1996.

Jože Tavcar, PhD

Domel d.d.

Otoki 21, SI-4228 Železniki, Slovenia

Tel. +386 4 5117-387, Fax. +386 4 5117-362

Email: joze.tavcar@domel.si